

Robust Telematics Health Monitoring and Dispatching Management System Based on IoT and M2M Technologies

M.Ali Farahpour
M.Sc. Information Security
Electron IoT Co, Science &
Technology Park
Hamedan, Iran
farahpour@electrons.ir

Ebrahim Sabouri
BSc. Mechanical Engineering
Asan Khordo, Mining & Construction
Machinery Co.
Tehran, Iran
esabouri@gmail.com

ABSTRACT

The Internet of Things is a telecommunication phenomenon which has been introduced during these years, wherein every physical thing would be equipped with electronic parts such as transceivers, sensors, Microcontrollers, RFID, actuators, and proper procedures that can make them able to interact with each other and even with the people, turning into an integrated portion of the Internet. The IOT in fact can be used in various areas, including industrial automation, automotive, home automation, transportation and fleet management, medical aids, smart power management, and a lot of other domains and needless to say that is one of the principles and integral parts of smart city and in a comprehensive view smart world. In this paper, first, we introduce our patent called "Intelligent Health Monitoring and Dispatching System (IHMDs)" based on IOT, telematics and M2M technologies for fleet management on construction, mining, and agriculture machinery. Then we will discuss how these type of systems can be used in smart cities and help to urban management. This system has been installed on more than 100 mining equipment (Dump-truck, Excavator, Loader, etc.) in five big iron mines in Iran and helps companies to maximize safety and increase their productivity. IHMDs is an embedded system comprises 5 main parts: sensors, controllers, industrial PC and a touch panel, network transceiver (GPRS/Wi-Fi), and GPS. A cloud-based software which uses GPS coordinates, artificial intelligence methods, queueing theory and shortest path algorithms provides dispatching and maintenance processes.

CCS CONCEPTS

• **Computer systems organization** → **Embedded systems; Firmware, Embedded hardware** • **Networks services** → Cloud Computing

KEYWORDS

Internet of Things, M2M, Smart City, Embedded System, Cloud Computing, Telematics

1 INTRODUCTION

The Internet of Things is the world of communications wherein physical objects connect with together so that the

invisible will become visible and information from smart things conduct wise actions. They can reveal their position, their status and tell how can we optimize their productivity. They can save time, maximize performance and most significantly, make our life easier.

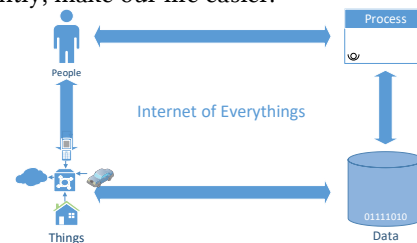

Figure 1: The Internet of Everything

One usage of IoT is in transportation and fleet management. Things in this scenario are expensive heavy machinery which used in the variety of industries such as mining, construction, transportation, and agriculture. Preventing them from failure and steering them in the optimum route can help organizations to decrease their costs and increase their net profit. Reliable, cost-efficient, and economical operations of these vehicles have increased a necessary demand for the real-time telematics monitoring system based on the IoT, and the main duty is to interpret data somehow can get meaningful information [27].

Common procedures cannot satisfy the needs of these vehicles on the performance, and consistency of data transmitting and counterbalance between the management system and expenses. Complicated architecture, improper operating situations, along with the long-time working hour with massive payload, cause numerous flaws in these vehicles, moreover, death casualties may occur. The vast geographical distribution of vehicles on-site leads to spending excessive maintenance costs and very long reaction time for the equipment's technician to getting access to the site. Furthermore, many drivers do not have enough knowledge about alarms which appear in the dashboard or if they have, do not notify the maintenance team. These type of problems have certainly negative effects on the development and cost-effectiveness of the projects [1].

On the other side, applying computerized automatic systems for heavy machinery dispatching perform a significant duty in reducing the transportation costs which frequently indicate the much of the costs allocated to various industries (for example, in surface mines involves around fifty percent of production costs) [18]. Therefore, applying an intelligent fleet dispatching strategy is essentially vital and utilitarian in the majority of the mines. The latest reports reveal that by reducing travel time of trucks and the corresponding waiting time of assigned shovel because of using a fleet dispatching system, the productivity rate is noticeably increased [2]. Computer-based fleet dispatching and maintenance systems utilizing algorithms, approaches and precise applications, are instances of these type of technologies. Designing comprehensive cloud-based applications and telematics Systems based on IoT corresponding to specific mine's situations are known as the most significant tasks associated with a fleet management system in the mining industry in the future.

Since the transport fleet of the majority of mining companies are dump-trucks with different commercial brands and various capabilities, by performing analysis on mathematical-based and artificial intelligence approaches, creative techniques, functional optimization methods along with the most effective strategies to improving the robust software for real-time dispatching and health monitoring system were elected. Eventually, a comprehensive model suitable for the needs of a fleet with various capabilities was designed by applying a hybrid approach of integer programming flow networks and Fuzzy based system in IHMDS project.

In two next sections we will study three similar systems and their features besides their weaknesses, then related works in this area are discussed and in the fourth section we will talk about IHMDS and its results, finally, there are some discussions related to infrastructure and hardware requirements for using this type of system and benefits which such systems can provide to the smart cities.

2 SIMILAR EXISTING SYSTEMS

2.1 Caterpillar VIMS

VIMS (Vital Information Management System) is a built-in mining information system, designed by Caterpillar, Inc. the world's greatest factory of construction machinery. VIMS enables monitoring of machine health, performance, vehicle and materials movement, and drilling operations. It offers the ability to connect on-site equipment to a central office and various mining information systems [3]. This system has an embedded controller which collects data of sensors related to engine

and payload then stores them in its limited storage (only 2899 records) and after that replaces the newest record with oldest record. Managers can extract data by downloading with cable on laptop locally or by using its RF module on Wireless or Satellite communication remotely which considered as M2M [8]. Most important provided data are payload data, GPS location, engine speed, movement speed, engine oil pressure, blow-by pressure, fuel consumption rate, boost pressure, exhaust temperatures, and etc. [7]. One of the weaknesses of this system is presenting raw data and its software provides general graphs and operators must process them whereas this is a time-consuming work [9]. In order to get data with their relevant positions, it has a GPS, but it does not have dispatching system. Driver authentication is by using a keypad. Since this system is expensive so it is installed on some specific models and Caterpillar has been designed it exclusively for its products. It does not have Tire pressure monitoring system (TPMS) and Monitor for interacting with the driver.

2.2 Komatsu KOMTRAX & VHMS

KOMTRAX and VHMS (Vehicle Health Monitoring System) are exclusive monitoring systems designed by Komatsu, second biggest manufacturer of mining and construction equipment in the world. The application of these systems are similar to VIMS, however, they do not have exclusive RF Module and only provide a LAN port which can be connected to any wireless network. KOMTRAX facilitates machine performance and can represent a major cost advantage. It uses satellite communication and allows proactive and preventive maintenance and assists efficiently in running a business. The added value of the equipment is enhanced, as owners gain easy access to the accurate history of a machine [4]. VHMS is a standard on Komatsu large size mining vehicles and is important item for monitoring the status of each vehicle and to assists reduce the costs. Detailed operational and technical data is collected by a VHMS onboard controller [5]. All weaknesses related to VIMS exists in Komatsu Systems [6].

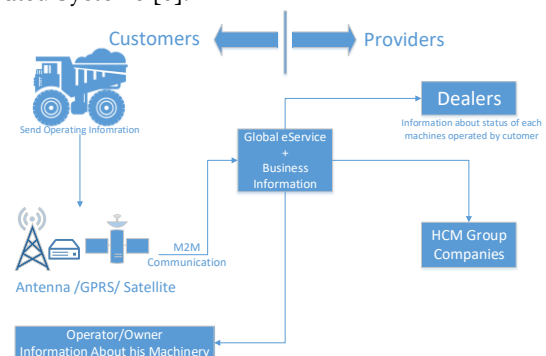

Figure 2: Architecture of OEM's Remote Monitoring System

Figure 2 demonstrates a general view of the functionality of these systems and one of the privacy issues related to it is that information related to vehicles first of all transfers to the manufacturer's database and the manufacturer can analyze the status of them. This issue has two sides, if the equipment is in the guarantee period it can help to the manufacturer to find their flaws and defects, but if it is not, there are a lot of complaints from owners, because manufacturers can observe the behavior of owners.

2.3 MODULAR MINING SYSTEM

Modular Mining Systems, Inc. is a company that develops a fleet management system in mining and now it is subsidiary of Komatsu Company. It has two main products: DISPATCH Fleet Management System (DFMS) and MineCare [10]. DFMS designed for open-pit mines and enables clients to apply particular productivity techniques with mining tools. It provides communication hardware and software, GPS-based machinery positioning, vehicle health and maintenance monitoring, and production reporting. In order to enhance the fleet availability, MineCare offers real-time vehicle health management, Remote status monitoring, trending, warning event handling, maintenance histories, operation tracking, sources analysis, and operational information. Their real-time cloud-based software has many features however, they focus on the software and interfaces for interacting with mentioned OEM (Original Equipment Manufacturer) Health Monitoring systems. DFMS has cabin's touch panel for interacting with the driver. Their interfaces only can communicate and extract data from different brands which have such mentioned type systems. It should be noted none of their products have TPMS for monitoring tire status and their software only analyze those sensors data which OEM controller provides.

As mentioned before, above systems are installed only on more expensive equipment (for example Komatsu HD465-7 and above, and lower model trucks like HD325-7 do not have it) but in many mining companies there are various types and brands of equipment and basically, a small portion of HDOR (Heavy-Duty Off-Road) vehicles are presently equipped with these kinds of controllers. For example, a study conducted in 2014 by the Equipment Manufacturers Association discovered that 62 percent of U.S. construction companies lacked any plan to apply such systems in the near future [23].

3 RELATED WORKS

History of First Vehicle Monitoring System returns to 1968 with an article titled "An Analytic and experimental evaluation of alternative methods for automatic vehicle monitoring" was introduced [12] and the first specific system related to Vehicle Health monitoring was "Study of Advanced Automatic Diagnostic/Prognostic Test Equipment for Maintenance of Military Automotive Vehicles" which sponsored by DARPA [13] and during the time many signs of progress have emerged. Vehicle Dispatching Systems theories started in 1966 with a paper titled "Optimal Dispatching Policies by Dynamic Programming" provided by MIT [14] and the first Computerized Dispatching system was introduced by West Virginia University with the same name in 1970 [15]. One of the first real-time dispatching systems which used in mining industries was "Truck and Shovel Dispatching Rules Assessment Using Simulation" provided in 1986. In this paper, authors explain that dispatching methods are categorized into 3 main groups: manual, semi-automated and fully automated and then discussed match factor, mixed heuristic rules, mathematical programming and then simulation program and results [16]. Since GPS data plays an important role in a dispatching system most such projects started in mid-eighties after that U.S government declared that Global positioning system (GPS) would be presented for civilian usages [17].

Today much theoretical research is in progress and many algorithms and approaches have been discussed related to both health monitoring and dispatching but for sake of brevity and focus on the main topic of this article which is related to IoT we do not open theoretical discussion expansively and just a brief mention to some recent studies are presented.

Caridá et al. discussed two dispatching approaches for FMS (Fleet Management System) based on hierarchical fuzzy rule-based model and adaptive genetic fuzzy system [19]. Zhang et al. introduced an Integer programming method for Truck-Shovel Dispatching. They presented a mathematical approach by applying integer programming method as a way to model and solve truck-shovel dispatching problem [20].

Babu et al. introduced a vehicle health monitoring system based on a fuzzy theory to evaluate performance prediction and enhance the health monitoring of a vehicle and then present several suggestions for calibration. Their focuses are on engine quality, battery quality, gas emission by using, IOT-based sensors, and an Android app. [21]. Rodger presents a new Integrated Vehicle Health Maintenance System (IVHMS) based on feedback and fault detection. A fuzzy multi-sensor data fusion Kalman model

has employed to assist IVHMS in reducing risk of failure. He used Can Bus Protocol for obtaining vehicle status [22].

4 IHMDS SYSTEM

IHMDS is a comprehensive IoT-based project which branded by TrackTruck enterprise name. we have been worked on this system for more than 4 years and registered it as a patent. TrackTruck has been installed on more than 50 HDOR Vehicles. he is composed of three main parts:

- Cloud-based Software
- Embedded Hardware
- Network Infrastructure

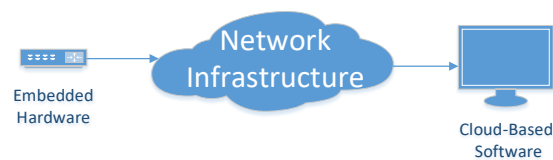

Figure 3: IHMDS Main Parts.

By doing several studies on many such systems, obtaining experiences and receiving mining companies' reactions and requirements, we could design a robust system with specific features.

Cloud-based software has been developed with more than 60,000 lines of code using PHP, JavaScript, CSS, HTML5, and MySQL on a Linux based cloud server that by using proper algorithms, analyzes HDORs' data in four topics:

- Real-time Dispatching & Fleet Management
- Diagnostic/ Prognostic for Maintenance
- Drilling Management
- Human Resource Management (HRM)

The software developed in such way which not only can process raw data of OEM controllers (such as Komatsu, Caterpillar, ...) but also can process obtained data from designed hardware. It can analyze GPS data and provide semi-automated dispatching (fully automated dispatching is in progress). It shows the position of equipment (trucks, shovels, loader, ...) and dump-sites on the map and by using shortest path algorithms, queueing theory, and driver's behavior dispatches each truck to assigned shovel. For example, each driver (shovel or truck driver) has different capability and ability (such as time needed for rock digging and filling truck), so by analyzing their specifications during a time we consider a factor and apply it on dispatching system. Also by using Artificial Intelligence algorithms and excavating real-time sensors data, it predicts possible failures or existing problems and then

produces warnings and suggestions and sends them to the assigned manager by using SMS or messaging apps (Telegram, WeChat, ...). In this software, there are many graphs and tables which can help the technical team to observe the health status (such as tire status, engine status, fuel consumption, machine history, working time, ...) of each machine or the entire fleet in a glance. It also provides the possibility of adjusting maintenance schedules and it sends a notification to a pre-defined account when a vehicle is close to its service time. drilling management section by evaluating and generating many graphs and tables (transferred waste or mineral material volumes) helps drilling team to optimize the productivity and plan for future development plans. In the HRM section, there are tools for monitoring drivers' behavior related to safety (such as over-speed, overload, ...) or producing reports related to productivity or drivers' salaries (such as payload amount, number of services, cycle time, ...).

As it mentioned in previous sections there are many HDORs which do not have OEM Controllers and many companies have various types and brands HDOR, therefore, in order to solve this problem, we designed an embedded hardware which can work with either OEM Controllers and machines which do not have a Controller. The hardware branded with VRMS-100 enterprise name and is composed of six main parts:

- Sensors
- Controller
- Industrial Computer & Touch Panel
- Transceiver & Antenna (GPRS/Wi-Fi)
- GPS & Antenna
- Rear/Road/Cabin IP-Based Cameras.

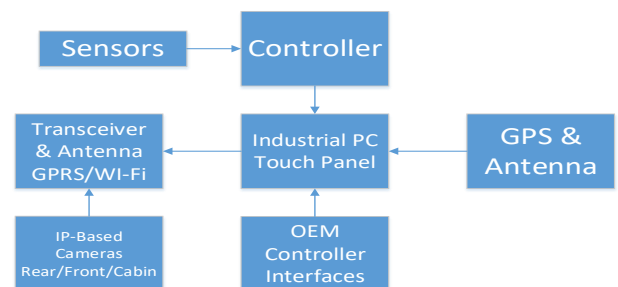

Figure 4: IHMDS main parts

It can transmit data with four methods:

- Mobile GPRS Communication: 4G/3G
- Wireless 802.11ac: Tower or ad-hoc Network
- Mobile Application: Bluetooth
- PC Download Tool: Cable

Industrial PC has three interfaces for obtaining sensors' data:

- Interface for communicating with OEM controller
- Interface for communicating with Can Bus (J1939)
- Interface for obtaining data from IHMDS Controller

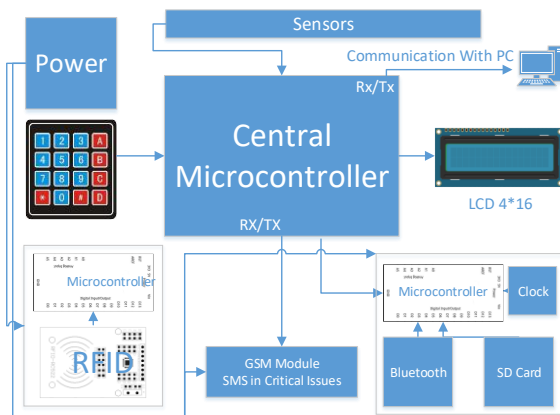

Figure 5: Schematic of IHMDS Controller

If HDOR has OEM Controller, industrial PC downloads raw data every few seconds from controller by using related interface, if it does not have OEM Controller but has Can-Bus system, industrial PC captures Can-Bus data continuously by Can-Bus analyzer interface, and if does not have neither one IHMDS controller measures sensors (Analog/Digital) every 4 seconds and transfers them to the industrial PC. The controller can measure 50 sensors such as Transmission, Engine Pressure, Engine Oil, Boost Pressure, Exhaust Temperature, Fuel Rate, Engine Speed, Engine Water Temperature, Transmission Temperature, Brake Pressure, payload, ... and needless to say that GPS data attached to vehicle data consistently.

Part four of IHMDS is Network Infrastructure if the mining site supports GPRS data, industrial PC can use a 4G/3G dongle and upload data directly to cloud server by using the internet. Figure 6 shows this process:

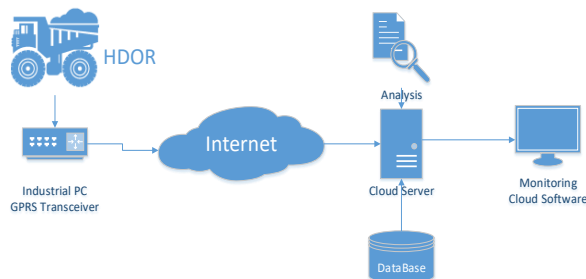

Figure 6: System schematic with GPRS Connection

If GPRS infrastructure is not provided, it is needed to use Wi-Fi towers (their numbers depend on the topographic situation of the site) and the local server. Data first transmitted to the local server and it uploads them to the cloud server by using the Internet. Also, there is a possibility for implementing ad-hoc network instead of Wi-Fi towers.

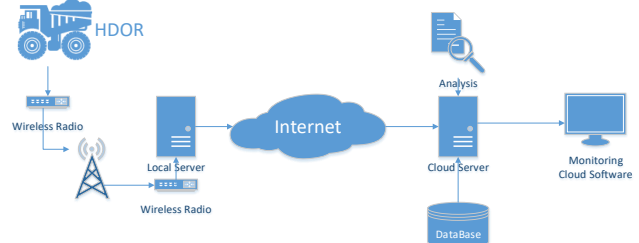

Figure 7: System Schematic with Wireless Connection

Technical team can also observe machine's status locally by using a smartphone (Bluetooth) or by using PC tool (cable) on a computer.

In the hardware part, we used C/C++ programming for designing Microcontroller's firmware with more than 20,000 lines of code. Main Controller consists of 4 sub-Microcontrollers for managing different parts (Memory Unit, Bluetooth, GPS, RFID, Sensors, Keypad, LCD, ...). For the Industrial PC, we used python and C++ programming for communicating with controller and server.

The touch panel is used for interacting with the driver for instance dispatching system, showing assigned shovel position, dump-site on the map or sending a notification to the driver, and by using network infrastructure VOIP system has been provided. For authenticating drivers, we use RFID access card instead of a keypad. Biometric authentication such as the fingerprint is not usable in the mining industry because of a hard work situation, workers' fingers do not have an acceptable pattern.

By using a 64Gb SD card for the VRMS-100 and due to the size of each record, it can be considered as an unlimited capacity for this system. The usage of this feature is for those times which system cannot send its data to the server for any reason so stores them until solving the problem.

The first part of VRMS-100 are sensors, these sensors are TPMS sensors, Vibration Sensor, and payload weighing sensors (many HDORs do not have payload meter).

TPMS stands for Tire Pressure Monitoring System which provides the status of each tire by measuring two things: temperature and pressure. Since HDOR tires are expensive consumer goods and have an effect on fuel consumption, then monitoring and controlling their status

can provide profitability for companies. [24]. We embed this system to IHMDS, and each module installed on tire's valve and sends the status of each tire every second to the controller remotely on 433 MHz frequency which considered as a WSN (Wireless Sensor Network) [25].

Vibration and accelerometer sensors were integrated with GPS data for recording routes situation, therefore by analyzing these information drilling team can detect those routes which can hurt the trucks.

The last part of IHMDS is IP-Based cameras this system uses three cameras for increasing safety: one camera monitors back of truck especially for those time which wants to move to the rear, one camera cover road for analyzing driver behavior and investigating accidents and one camera for the cabin which supervises driver. We are working on providing drowsiness detection system on this camera which can generate a warning when this issue happens. All of them also are monitored in dispatching office.

As it was said before, data collection is a significant work in the mining industry. Many organizations spend a lot of money and time to be able to get several types of information, including productivity rates, cycle times, delays, fuel consumption, working hours, and so on. Raw data must be mined and formatted before generating of daily, weekly, monthly, and annually reports. There exist conventional techniques which can be employed for data collection, such as operator's daily production book, engineer's field time study, and common information systems. These tasks are highly time-consuming [26] so using IoT-based approaches can improve productivity in this area.

For sake of brevity, we just provide some comparison in some cases related to one of the big mining company in Iran. It is necessary to mention that all data in our database are encrypted with symmetric keys which generated by clients and we do not have access to them and for this study, we got their permission and with their collaboration got access to data. Figure 8 compares payload amount in each hour of a day in first 2 months of implementing this system with same months in one year later.

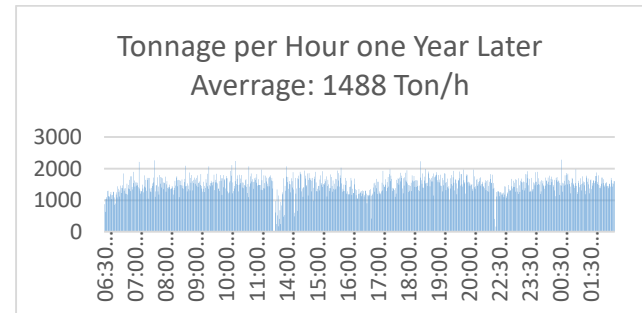
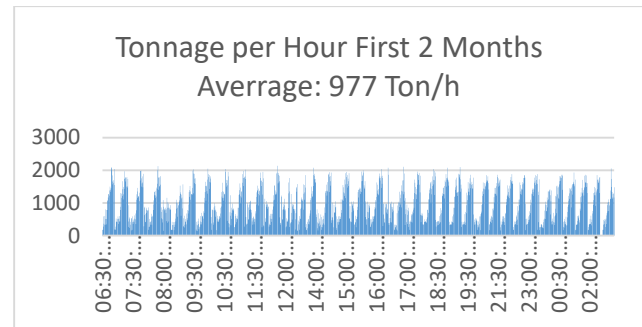

Figure 8: Comparing Payload Amount Per Hour in Each Day

Figure 9 demonstrates maximum speed. As it shows in the first days all speeds are more than 40 Km/h, but over the time it has been decreased to less than 40 Km/h which is a proper speed for this trucks and can decrease the probability of an accident and hazardous.

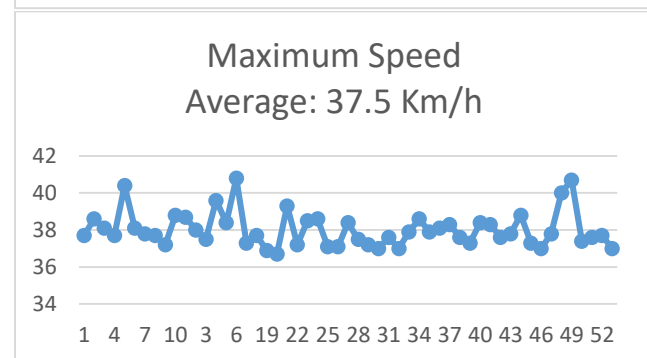
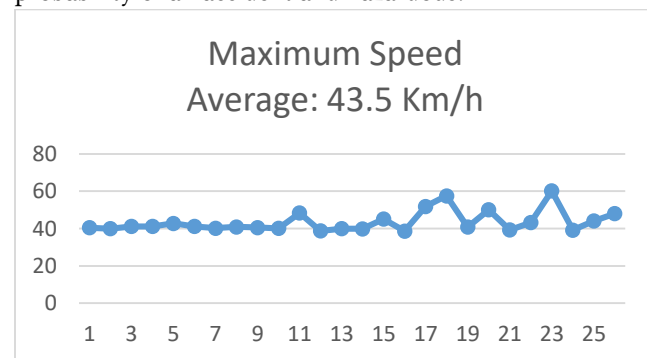

Figure 9: Comparing Recorded Maximum Speed

Figure 10 shows movement times of trucks which shows the impact of dispatching process. For example, loading time has been decreased from 19 percent to 9 percent.

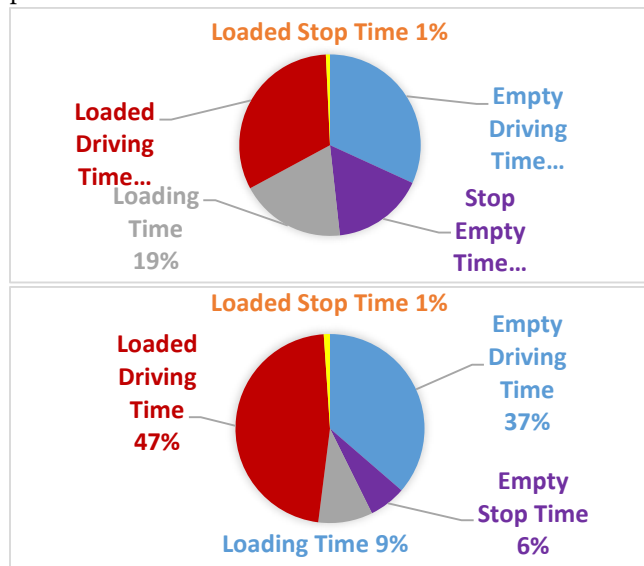

Figure 10: Comparing Movement Times

This system has been installed on more than 50 equipment in 5 big iron mines of Iran and provides real-time monitoring, therefore, companies which use this system could increase their profitability.

5 CONCLUSION

nowadays is the world of IOT and this technology without sensors is meaningless. The most important challenge will be to translate received data from sensors into useful information which can optimize human life and industry such as vehicle efficiency, therefore improving artificial intelligence approaches and automated systems are considered as the main task in this path.

Based on a commercial study center claim, the size of interconnected fleet management solutions will climax at ninety percent of whole commercial vehicles and about 26 billion devices will be in the IoT-connected world by 2020 [28] [29]. A conventional study by Cisco and DHL reveals that IoT technological innovations such as assets tracking can have an effect of near \$1.9 Trillion in Supply Chain Management which plays a role in smart cities [29]. Today's demands for low-carbon safe, and power efficient may barely be performed without valuable transportation and traffic administration services. We believe that our system can be implemented in a smart city and makes a better utilization of the public sources, raises the quality of the services presented to the residents, whereas decreases

the operating expenses of the public management. Such systems can provide several advantages in the optimization and management of common public services, like transportation and parking, maintenance and monitoring of public locations, compatibility of clinics, and school. For example, providing a dispatching system for emergency conditions in urban areas is vital, and by using such systems we can assign a proper ambulance to the patient based on distances, crowded areas, capability and capacity of the hospital, and patient congestion at the hospitals. By deploying a comprehensive health monitoring system for public transport vehicles (bus, taxi, ...) and using an air quality surveillance system, it can present a service to track the fuel consumption and urban contaminants of the entire city which these vehicles are responsible for it. Using air pollution detection sensors beside health monitoring on such vehicles, can not only help to reduce air pollution but also can improve the services so that a central office can monitor and predict possible downtime of vehicles and sends them to workshop before failure or by adopting combination of dispatching system, acoustic wave sensors and crowded areas data along the stations and roads, it will be possible to manage the public transport vehicles based on those areas which need more. Although improving hardware and network infrastructure (such as 4G and 5G) for performing IoT in a city is another issue which must be considered.

ACKNOWLEDGMENTS

The authors wish to acknowledge Apadana Kavosh Iranian Mining Company and Science & Technology Park of Hamedan for Their supports during our activities related to this system. Also, the authors would like to thank the editors and reviewers of this paper for their comments and valuable remarks.

REFERENCES

- [1] Xiang Zhou M.J, Luo E., and Qing X. 2015. Industrial-QoS-Oriented Remote Wireless Communication Protocol for the Internet of Construction Vehicles. *IEEE Transactions on Industrial Electronics* 62, 11 (2015), 7103–7113
- [2] Kaveh Ahangaran D., Yasrebi A.B, Wetherelt A., and Foster F. 2012. Real-time dispatching modelling for trucks with different capacities in open pit. *Archives of Mining Sciences* 57, 1 (2012).
- [3] Ataman I.K., Golosinski T.S. 2000. Knowledge Discovery in Mining Truck Condition and Performance Databases
- [4] S. Arakawa. 2002. Development and deployment of KOMTRAX STEP 2, Komatsu Technical Report, vol. 48, no. 150, pp. 8–14, 2002
- [5] Murakami, T., Saigo, T., Ohkura, Y., Okawa, Y., and Taninaga, T. 2002. Development of vehicle health monitoring system (VHMS/WebCARE) for large-sized construction machine. Komatsu's Technical Rep., Komatsu, 15–21
- [6] Fujikawa Y., Akutsu S., and Ono J. 2016. Context Management Approach to Value Co-creation: Toward Dynamic Process Model of Customer as Value Co-creator. *Global Perspectives on Service Science: Japan Service Science: Research and Innovations in the Service Economy* (2016), 31–47
- [7] Michael E. Kiziroglou, David E. Boyle, Eric M. Yeatman, and Jan J. Cilliers, 2017. Opportunities for Sensing Systems in Mining. *IEEE Transactions on Industrial Informatics*, Vol 13, No. 1, February 2017

- [8] R. Duke-Woolley. 2012. Findings from ESA SAMOS project - Satellite M2m Observatory Study. 6th Advanced Satellite Multimedia Systems Conference (ASMS) and 12th Signal Processing for Space Communications Workshop (SPSC), 5-7 Sept. 2012.
- [9] Henze, Joshua C. 2015. Haul Truck Payload Modelling Using Strut Pressure. PLOS Biology, Public Library of Science, 1 Nov. 2015, doi.org/10.7939/R3GF0N734
- [10] <http://www.modularmining.com>
- [11] Ashton, W.S., Bain, A.C. 2012 Assessing the Short mental distance. in Eco industrial networks. 2012 J. Ind. Ecol. 16, 70e82
- [12] Roth S.H. 1976 History of automatic vehicle monitoring (AVM). 1976 IEEE Trans. Veh. Technol., vol. VT-26, pp. 2-6, Feb. 1976
- [13] Creswick, F.A., Wyler, E.N. 1976 Study of Advanced Automatic Diagnostic/Prognostic Test Equipment for Maintenance of Military Automotive Vehicles. dtic.mil
- [14] Ward, D.E. 1966 Optimal Dispatching Policies by Dynamic Programming. trid.trb.org
- [15] Takhshi, N. 1970 COMPUTERIZED DISPATCHING SYSTEM. West Virginia University
- [16] Lizotte Y, Bonates E. 1987 Truck and shovel dispatching rules assessment using simulation. Mining Sci Technol 1987;5:45-58
- [17] Schroerer D, Elena M. Technology Transfer. 2018 Ashgate. p. 80. ISBN 0-7546-2045-X. Retrieved May 25, 2018
- [18] Dindarloo S.R., Osanloo M., Frimpong S. A. 2015. stochastic simulation framework for truck and shovel selection and sizing in open pit mines. J S Afr Inst Min Metall (SAIMM J) 2015;115(1):209-19.
- [19] Caridá V., Morandin Jr O., Tuma C. 2015 Approaches of fuzzy systems applied to an AGV dispatching system in a FMS. Int J Adv Manuf Technol:1-11
- [20] Lijun Zhang and Xiaohua Xia. 2015. An Integer Programming Approach for Truck-Shovel Dispatching Problem in Open-Pit Mines. Energy Procedia 75 (2015), 1779 & 1784. Clean, Efficient and Affordable Energy for a Sustainable Future: The 7th International Conference on Applied Energy (ICAE2015)
- [21] Babu, M., Anirudh, T. and Jayashree, P. 2016. Fuzzy system based vehicle health monitoring and performance calibration. 2016 International Conference on Electrical, Electronics, and Optimization Techniques (ICEEOT).
- [22] Rodger, J. 2012. Toward reducing failure risk in an integrated vehicle health maintenance system: A fuzzy multi-sensor data fusion Kalman filter approach for IVHMS. Expert Systems with Applications 39, 10, 9821-9836.
- [23] Saidani, M., Yannou, B., Leroy, Y. and Cluzel, F. 2018. Heavy vehicles on the road towards the circular economy: Analysis and comparison with the automotive industry. Resources, Conservation and Recycling 135, 108-122.
- [24] van Zyl, P., Goethem, S.v., Jansen, S., Kanarchos, S., Rexeis, M., Hausberger, S., Smokers, R. 2013. Study on tyre pressure monitoring systems (TPMS) as a means to reduce light-commercial and heavy-duty vehicles fuel consumption and co2 emissions. Final report, European Commission DG Clima. publications.tno.nl
- [25] Zhang, J., Liu, Q. and Zhong, Y. 2008. A Tire Pressure Monitoring System Based on Wireless Sensor Networks Technology. 2008 International Conference on Multimedia and Information Technology.
- [26] Terrazas Prado, P., Kecojevic, V., Bogunovic, D. and Mongeon, P. 2018. Truck cycle and delay automated data collection system in surface coal mining. Scielo.org.za. J. S. Afr. Inst. Min. Metall. vol.113 n.11 Johannesburg Nov. 2013.
- [27] Saidani, M., Yannou, B., Leroy, Y. and Cluzel, F. 2018. Heavy vehicles on the road towards the circular economy: Analysis and comparison with the automotive industry. Resources, Conservation and Recycling 135, 108-122.
- [28] Business Insider, U. 2016. Verizon's Telogis and John Deere have partnered on connected construction equipment. Retrieved from <http://uk.businessinsider.com/verizonstelogis-partners-with-john-deere-to-analyze-tractor-data-2016-11?IR=T>
- [29] Gartner. 2014. Gartner says the Internet of Things will transform the data center. Retrieved from <http://www.gartner.com/newsroom/id/2684616>
- [30] Amine, C., and Leyton, F. 2017. Internet of Things (IoT): To revolutionise supply chain management. Retrieved from <http://www.leyton.com/blog/?p=1286-internet-of-things-iiotto-revolutionize-supply-chain-management>

© 2018 Farahpoor et al. This is an open access article distributed under the terms of the Creative Commons Attribution License:

<http://creativecommons.org/licenses/by/4.0/> (the “License”), which permits unrestricted use, distribution, reproduction and adaptation in any medium and for any purpose provided that it is properly attributed. For attribution, the original author(s), title, publication source (PeerJ Preprints) and either DOI or URL of the article must be cited. Notwithstanding the ProQuest Terms and Conditions, you may use this content in accordance with the terms of the License.